

**PLANIT KITCHENS**

(Planit Enterprises p/l ACN 07612802)

**BSC Licence No: 81123C**

**Showroom 4365 1599**

**Factory 4355 5555**

**NAME:-**

Tullipan - Mantilla KITCHEN

24 Paddock Close  
ELERMORE VALE

PHONE:- 0439 383 622

EMAIL:- johnmmd@mantilla.net.au

**PLANS REMAIN THE PROPERTY OF PLANIT KITCHENS**

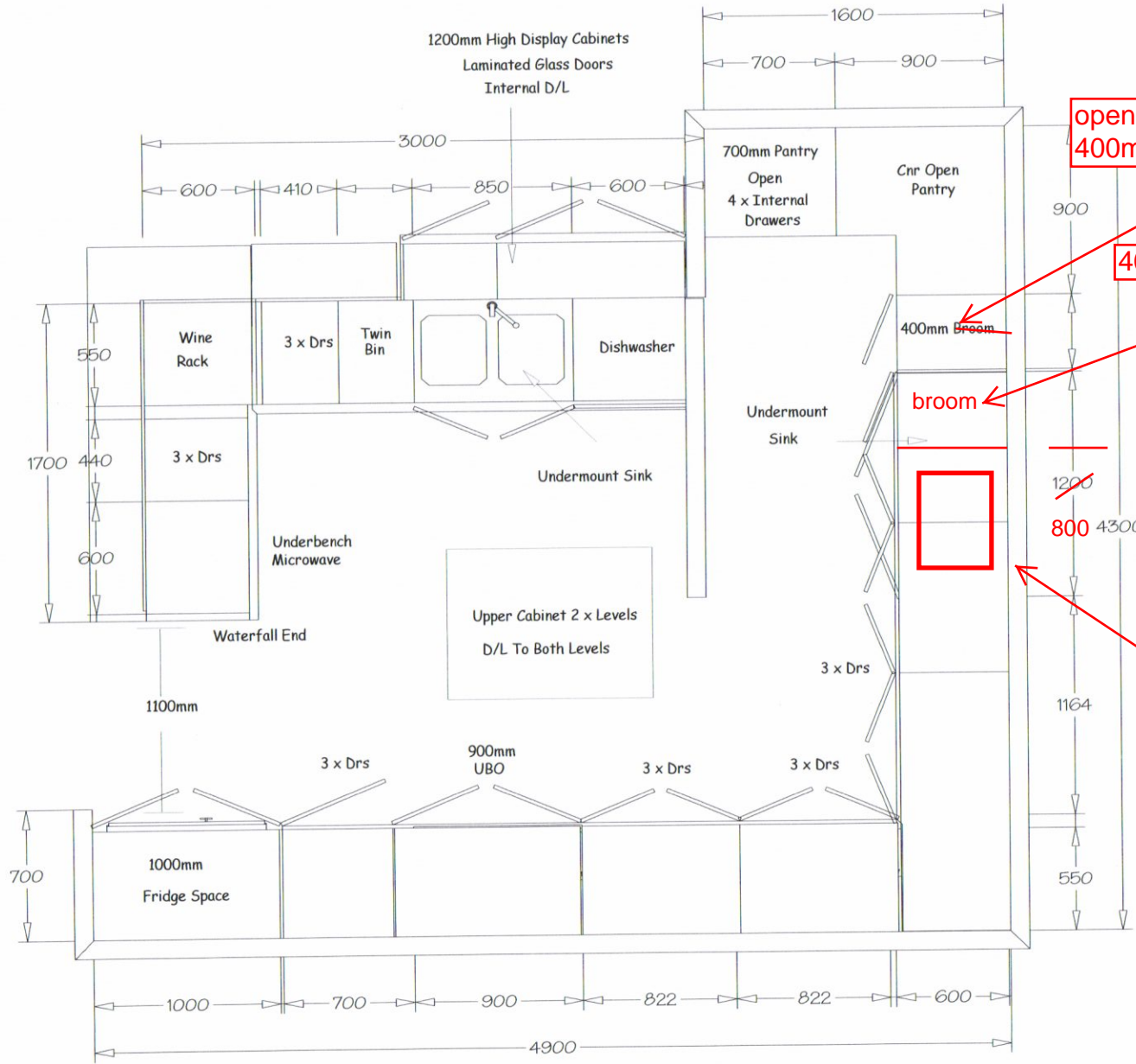

- Ceiling: 2740 High
- Cabinets: 2640 High
- Doors: Borgs Board
- Option: Polyurethane Style 1
- 20mm Standard Reconstituted Stone
- Handles: \$15 Value
- No Handles To Overheads
- Drawers: Metabox
- Option: Tandem Soft Close
- Kicks: As Doors
- Feature Doors: Laminated Glass
- Splashback: Glass

open pantry  
400mm

400mm broom

broom

sink

DATE DRAWN:- 2.7.15  
SOLD BY:-  
CHECK MEASURE BY:-  
DRAWN BY:- Georgia

# PLANIT KITCHENS

(Planit Enterprises p/l ACN 07612802)

BSC Licence No: 81123C

Showroom 4365 1599

Factory 4355 5555

## NAME:-

Tullipan - Mantilla KITCHEN

24 Paddock Close  
ELERMORE VALE

PHONE:- 0439 383 622

EMAIL:- johnmmd@mantilla.net.au

PLANS REMAIN THE PROPERTY OF PLANIT KITCHENS

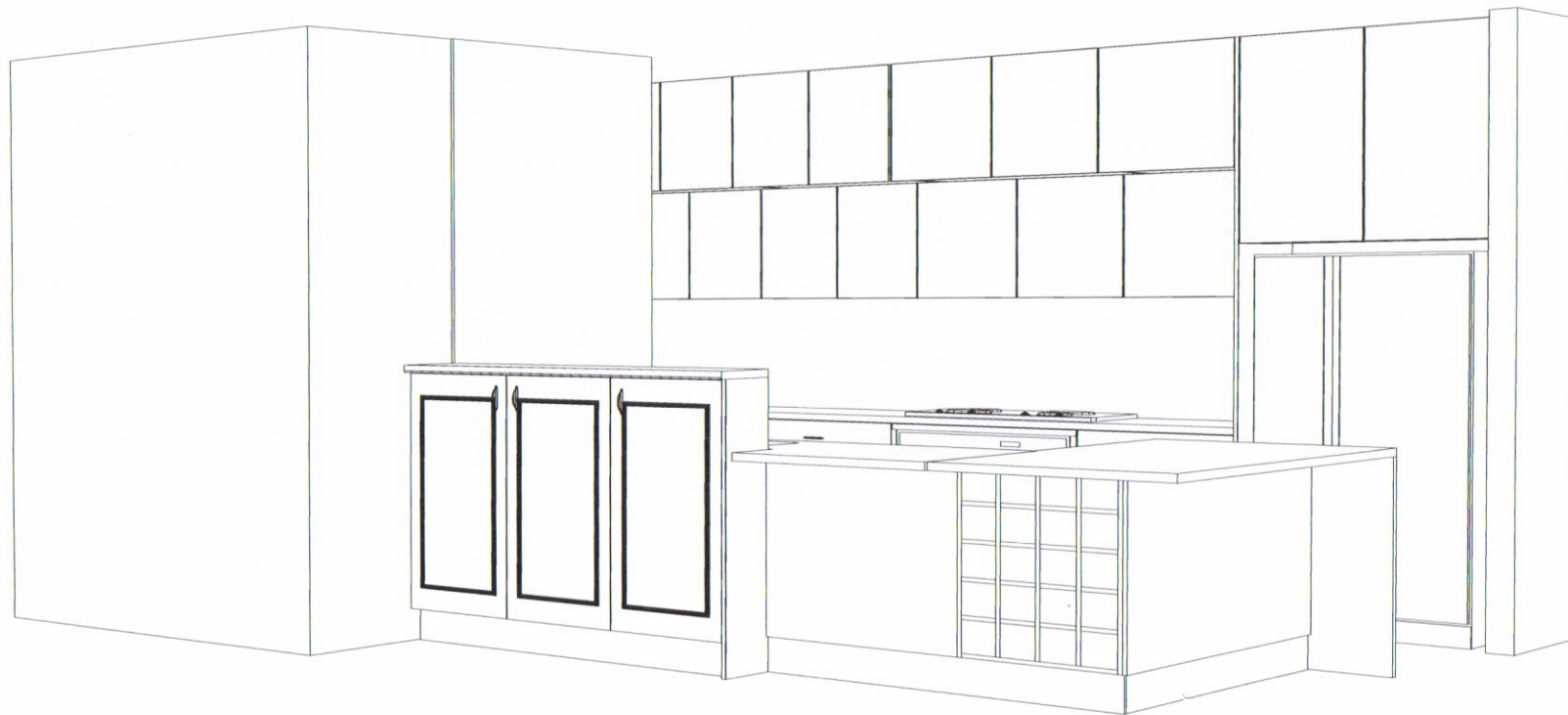

Ceiling: 2740 High

Cabinets: 2640 High

Doors: Borgs Board

Option: Polyurethane Style 1

Benchtop: 20mm Standard  
Reconstituted Stone

Handles: \$15 Value

No Handles To Overheads

Drawers: Metabox

Option: Tandem Soft Close

Kicks: As Doors

Feature Doors: Laminated  
Glass

Splashback: Glass

DATE DRAWN:- 2.7.15

SOLD BY:-

CHECK MEASURE BY:-

DRAWN BY:- Georgia

# PLANIT KITCHENS

(Planit Enterprises p/l ACN 07612802)

BSC Licence No: 81123C

Showroom 4365 1599

Factory 4355 5555

## NAME:-

Tullipan - Mantilla KITCHEN

24 Paddock Close  
ELERMORE VALE

PHONE:- 0439 383 622

EMAIL:- johnmmd@mantilla.net.au

PLANS REMAIN THE PROPERTY OF PLANIT KITCHENS

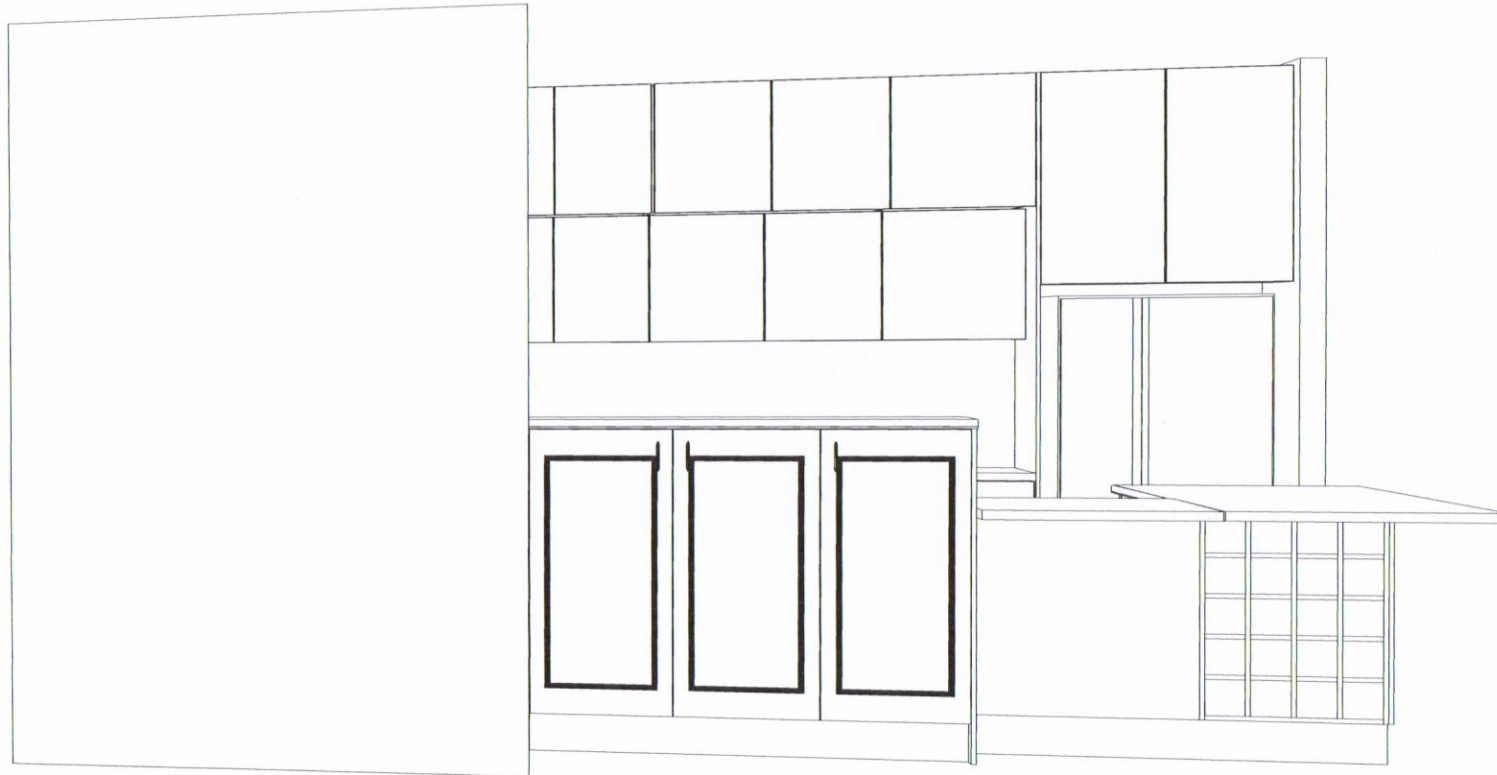

Ceiling: 2740 High

Cabinets: 2640 High

Doors: Borgs Board

Option: Polyurethane Style 1

Benchtop: 20mm Standard  
Reconstituted Stone

Handles: \$15 Value

No Handles To Overheads

Drawers: Metabox

Option: Tandem Soft Close

Kicks: As Doors

Feature Doors: Laminated  
Glass

Splashback: Glass

DATE DRAWN:- 2.7.15

SOLD BY:-

CHECK MEASURE BY:-

DRAWN BY:- Georgia

# PLANIT KITCHENS

(Planit Enterprises p/l ACN 07612802)

BSC Licence No: 81123C

Showroom 4365 1599

Factory 4355 5555

## NAME:-

Tullipan - Mantilla KITCHEN

24 Paddock Close  
ELERMORE VALE

PHONE:- 0439 383 622

EMAIL:- johnmmd@mantilla.net.au

PLANS REMAIN THE PROPERTY OF PLANIT KITCHENS



Ceiling: 2740 High

Cabinets: 2640 High

Doors: Borgs Board

Option: Polyurethane Style 1

Benchtop: 20mm Standard  
Reconstituted Stone

Handles: \$15 Value

No Handles To Overheads

Drawers: Metabox

Option: Tandem Soft Close

Kicks: As Doors

Feature Doors: Laminated  
Glass

Splashback: Glass

DATE DRAWN:- 2.7.15

SOLD BY:-

CHECK MEASURE BY:-

DRAWN BY:- Georgia

# PLANIT KITCHENS

(Planit Enterprises p/l ACN 07612802)

BSC Licence No: 81123C

Showroom 4365 1599

Factory 4355 5555

## NAME:-

Tullipan - Mantilla KITCHEN

24 Paddock Close  
ELERMORE VALE

PHONE:- 0439 383 622

EMAIL:- johnmmd@mantilla.net.au

PLANS REMAIN THE PROPERTY OF PLANIT KITCHENS

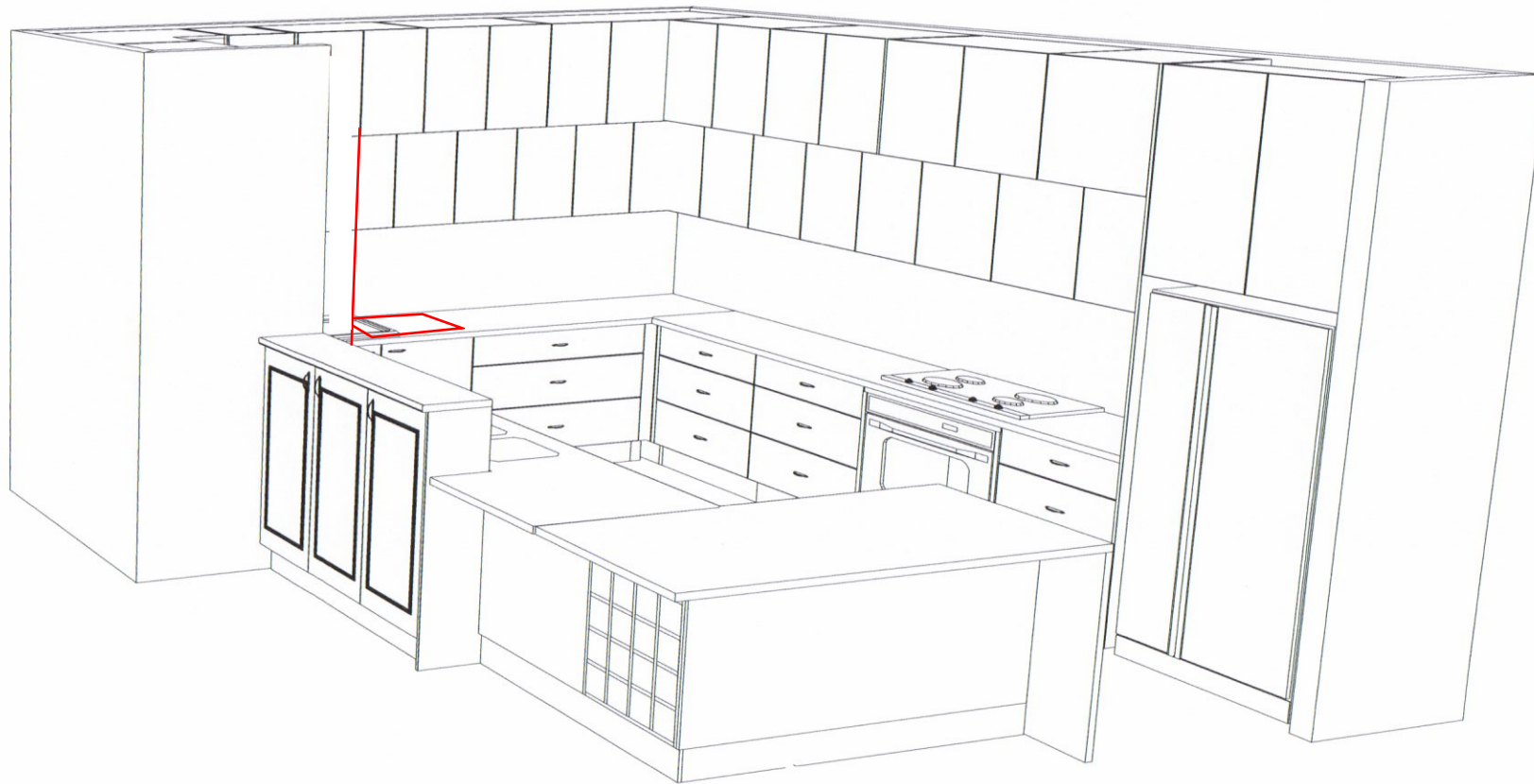

Ceiling: 2740 High

Cabinets: 2640 High

Doors: Borgs Board

Option: Polyurethane Style 1

Benchtop: 20mm Standard  
Reconstituted Stone

Handles: \$15 Value

No Handles To Overheads

Drawers: Metabox

Option: Tandem Soft Close

Kicks: As Doors

Feature Doors: Laminated  
Glass

Splashback: Glass

DATE DRAWN:- 2.7.15

SOLD BY:-

CHECK MEASURE BY:-

DRAWN BY:- Georgia

# PLANIT KITCHENS

(Planit Enterprises p/l ACN 07612802)

BSC Licence No: 81123C

Showroom 4365 1599

Factory 4355 5555

## NAME:-

Tullipan - Mantilla KITCHEN

24 Paddock Close  
ELERMORE VALE

PHONE:- 0439 383 622

EMAIL:- johnmmd@mantilla.net.au

PLANS REMAIN THE PROPERTY OF PLANIT KITCHENS

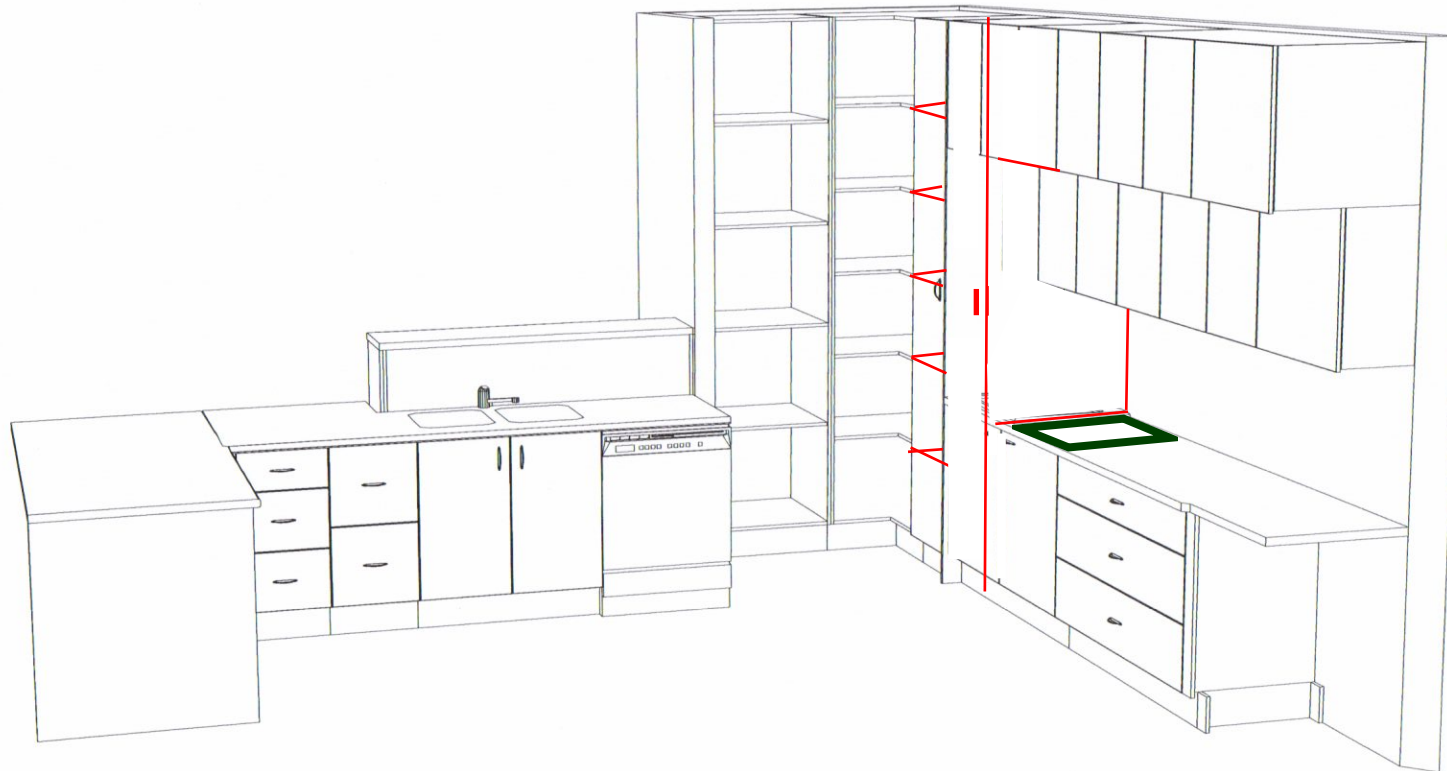

Ceiling: 2740 High

Cabinets: 2640 High

Doors: Borgs Board

Option: Polyurethane Style 1

Benchtop: 20mm Standard  
Reconstituted Stone

Handles: \$15 Value

No Handles To Overheads

Drawers: Metabox

Option: Tandem Soft Close

Kicks: As Doors

Feature Doors: Laminated  
Glass

Splashback: Glass

DATE DRAWN:- 2.7.15  
SOLD BY:-  
CHECK MEASURE BY:-  
DRAWN BY:- Georgia

**PLANIT KITCHENS**

(Planit Enterprises p/l ACN 07612802)

**BSC Licence No: 81123C**

**Showroom 4365 1599**

**Factory 4355 5555**

**NAME:-**

Tullipan - Mantilla KITCHEN

24 Paddock Close  
ELERMORE VALE

PHONE:- 0439 383 622

EMAIL:- johnmmd@mantilla.net.au

**PLANS REMAIN THE PROPERTY OF PLANIT KITCHENS**



Ceiling: 2740 High

Cabinets: 2640 High

Doors: Borgs Board

Option: Polyurethane Style 1

Benchtop: 20mm Standard  
Reconstituted Stone

Handles: \$15 Value

No Handles To Overheads

Drawers: Metabox

Option: Tandem Soft Close

Kicks: As Doors

Feature Doors: Laminated  
Glass

Splashback: Glass

DATE DRAWN:- 2.7.15

SOLD BY:-

CHECK MEASURE BY:-

DRAWN BY:- Georgia

**PLANIT KITCHENS**

(Planit Enterprises p/l ACN 07612802)

**BSC Licence No: 81123C**

**Showroom 4365 1599**

**Factory 4355 5555**

**NAME:-**

Tullipan - Mantilla KITCHEN  
24 Paddock Close  
ELERMORE VALE

PHONE:- 0439 383 622

EMAIL:- johnmmd@mantilla.net.au

**PLANS REMAIN THE PROPERTY OF PLANIT KITCHENS**

Ceiling: 2740 High

Cabinets: 2640 High

Doors: Borgs Board

Option: Polyurethane Style 1

Benchtop: 20mm Standard  
Reconstituted Stone

Handles: \$15 Value

No Handles To Overheads

Drawers: Metabox

Option: Tandem Soft Close

Kicks: As Doors

Feature Doors: Laminated  
Glass

Splashback: Glass

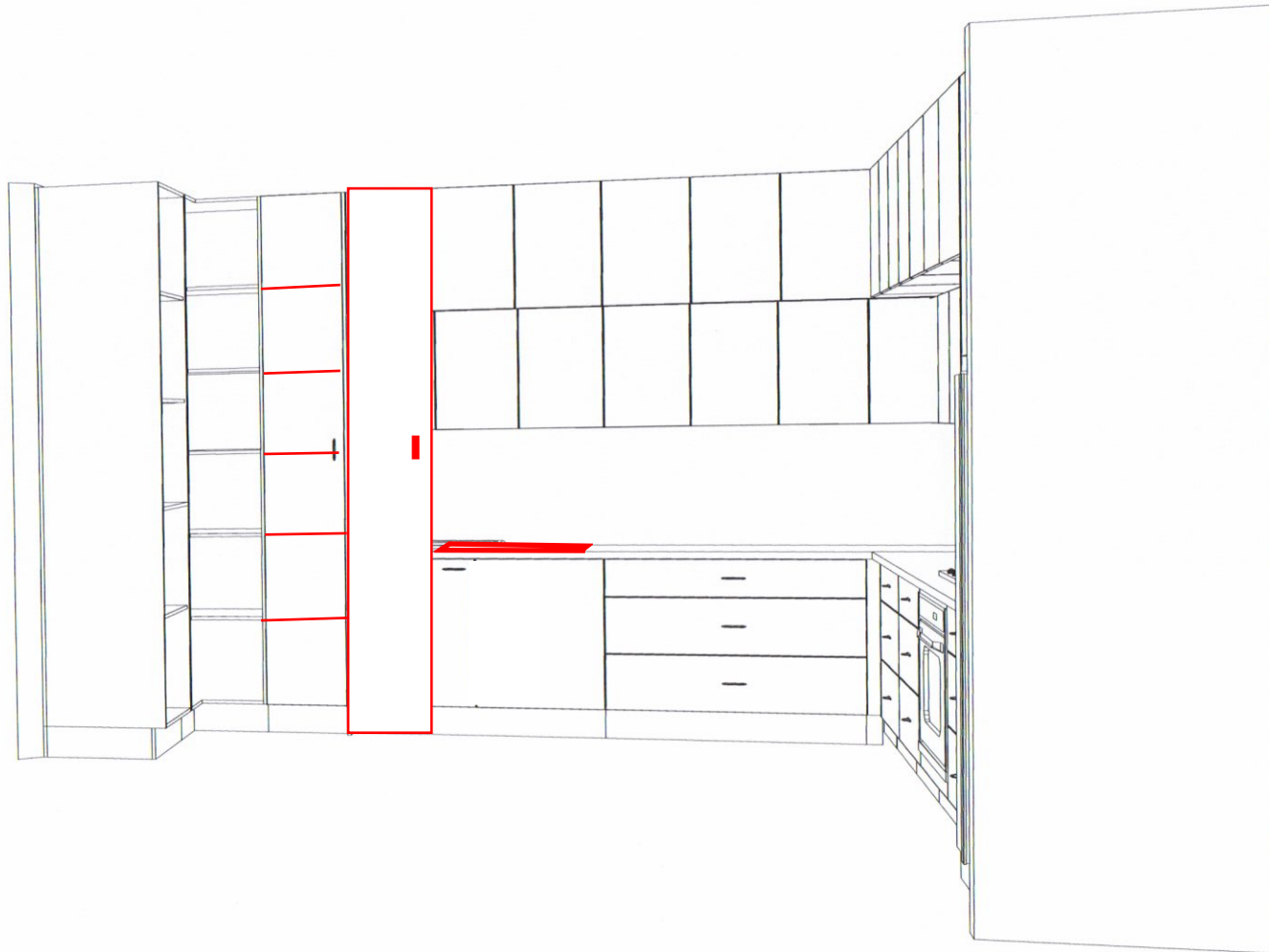

DATE DRAWN:- 2.7.15  
SOLD BY:-  
CHECK MEASURE BY:-  
DRAWN BY:- Georgia



**PLANIT KITCHENS**

(Planit Enterprises p/l ACN 07612802)

**BSC Licence No: 81123C**

**Showroom 4365 1599**

**Factory 4355 5555**

**NAME:-**

Tullipan - Mantilla LAUNDRY

24 Paddock Close

ELERMORE VALE

PHONE:- 0439 383 622

EMAIL:- johnmmd@mantilla.net.au

**PLANS REMAIN THE PROPERTY OF PLANIT KITCHENS**

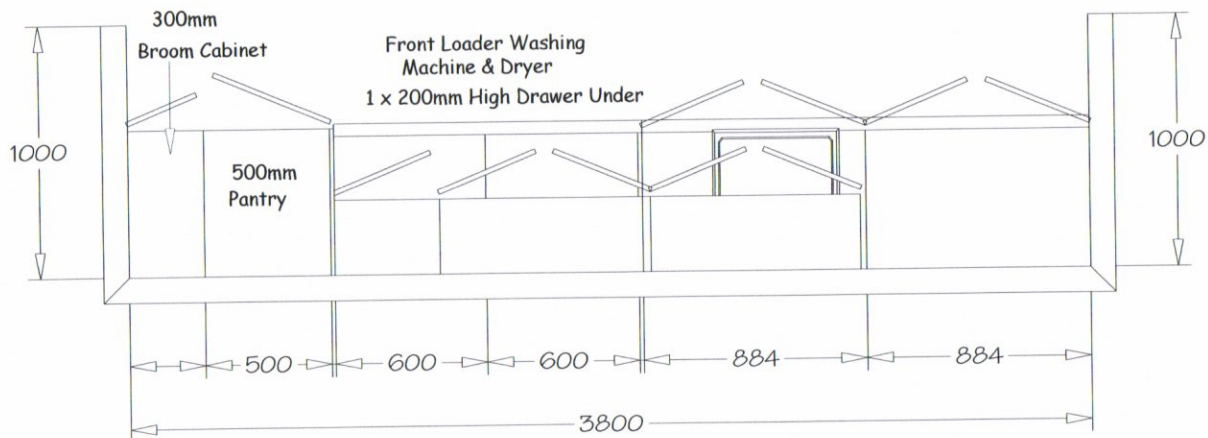

Ceiling: 2740 High

Cabinets: 2100 High

Doors: Borgs Board

Benchtop: Laminate

Handles: \$10 Value  
No Handles To Overheads

Drawers: Metabox

Kicks: Laminate

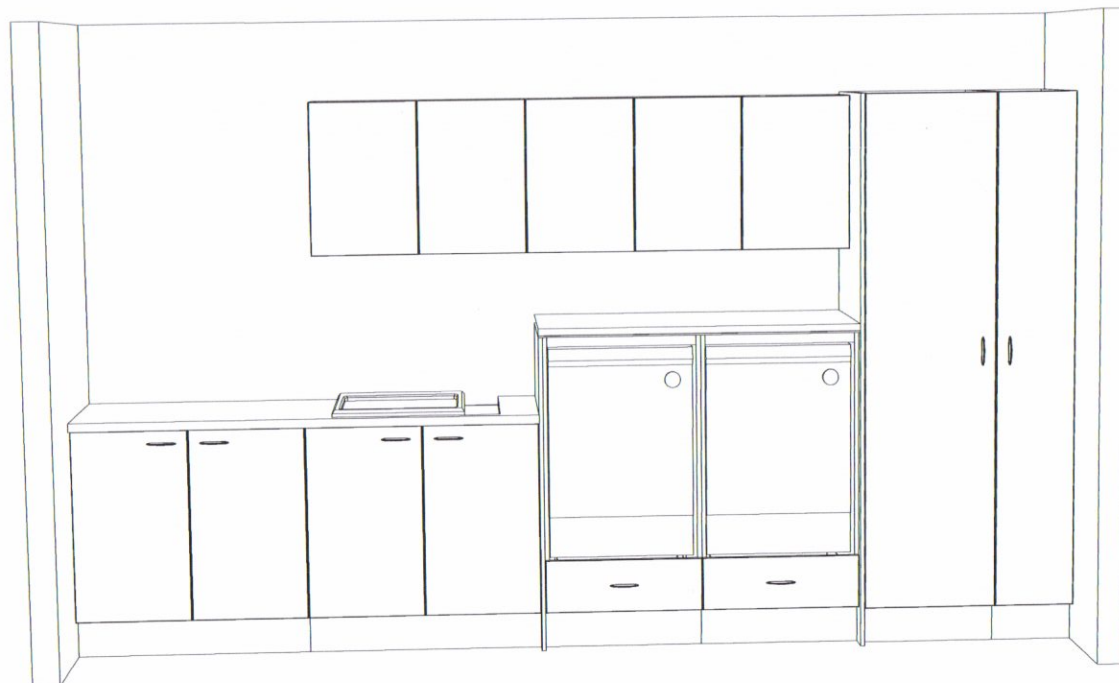

DATE DRAWN:- 4.7.15  
SOLD BY:-  
CHECK MEASURE BY:-  
DRAWN BY:- Georgia

**PLANIT KITCHENS**

(Planit Enterprises p/l ACN 07612802)

**BSC Licence No: 81123C**

**Showroom 4365 1599**

**Factory 4355 5555**

**NAME:-**

Tullipan - Mantilla  
24 Paddock Close  
ELERMORE VALE

**ALFRESCO**

PHONE:- 0439 383 622

EMAIL:- johnmmd@mantilla.net.au

**PLANS REMAIN THE PROPERTY OF PLANIT KITCHENS**

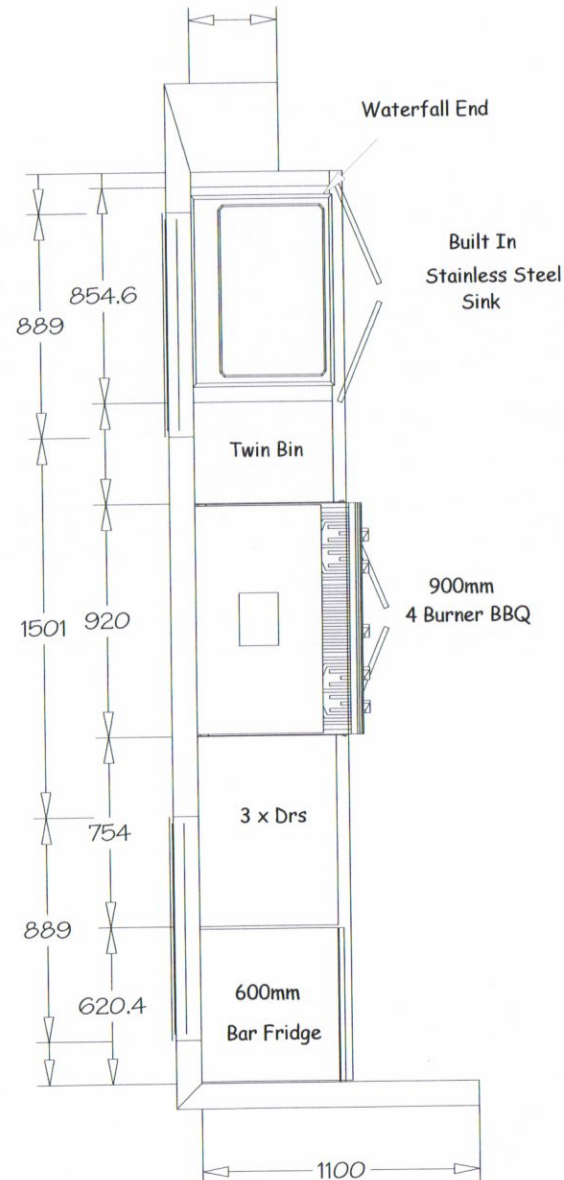

Ceiling: 2740 High

Cabinets: 910 High

Doors: Extreme V3H Stack  
Gotham Midnight

Carcass: Waterproof HMR

Benchtop: 60mm Stainless  
Steel

Handles: Built In

Drawers: Tandem Soft Close

Kicks: Tiled By Builder

DATE DRAWN:- 4.7.15  
SOLD BY:-  
CHECK MEASURE BY:-  
DRAWN BY:- Georgia

**PLANIT KITCHENS**

(Planit Enterprises p/l ACN 07612802)

**BSC Licence No: 81123C**

**Showroom 4365 1599**

**Factory 4355 5555**

**NAME:-**

Tullipan - Mantilla                      ALFRESCO  
24 Paddock Close  
ELERMORE VALE

PHONE:- 0439 383 622

EMAIL:- johnmmd@mantilla.net.au

**PLANS REMAIN THE PROPERTY OF PLANIT KITCHENS**



Ceiling: 2740 High

Cabinets: 910 High

Doors: Extreme V3H Stack  
Gotham Midnight

Carcass: Waterproof HMR

Benchtop: 60mm Stainless  
Steel

Handles: Built In

Drawers: Tandem Soft Close

Kicks: Tiled By Builder

DATE DRAWN:- 4.7.15

SOLD BY:-

CHECK MEASURE BY:-

DRAWN BY:- Georgia